

easYlite-200

Technical Manual | LED Lamp Expansion Module

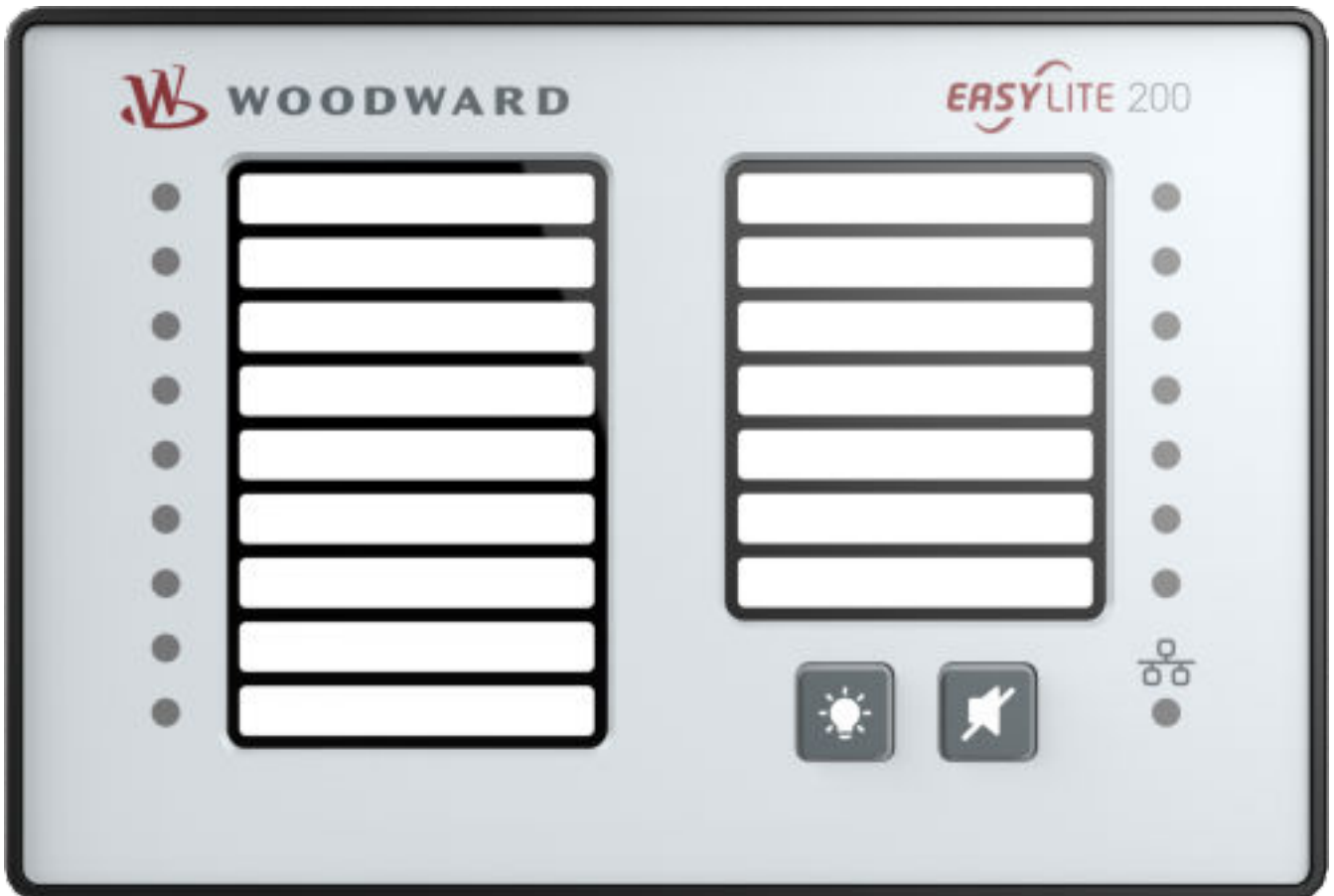

easYgen Expansion Module

Software Version 3.0.1.2

Document ID: B37903, Revision D - Build 51670

Manual (original)

This is no translation but the original Technical Manual in English.

Designed in Germany and Poland.

Woodward GmbH

Handwerkstr. 29

70565 Stuttgart

Germany

Telephone: +49 (0) 711 789 54-510

Fax: +49 (0) 711 789 54-101

E-mail: stgt-info@woodward.com

Internet: <http://www.woodward.com>

© 2021 Woodward GmbH. All rights reserved.

Brief Overview

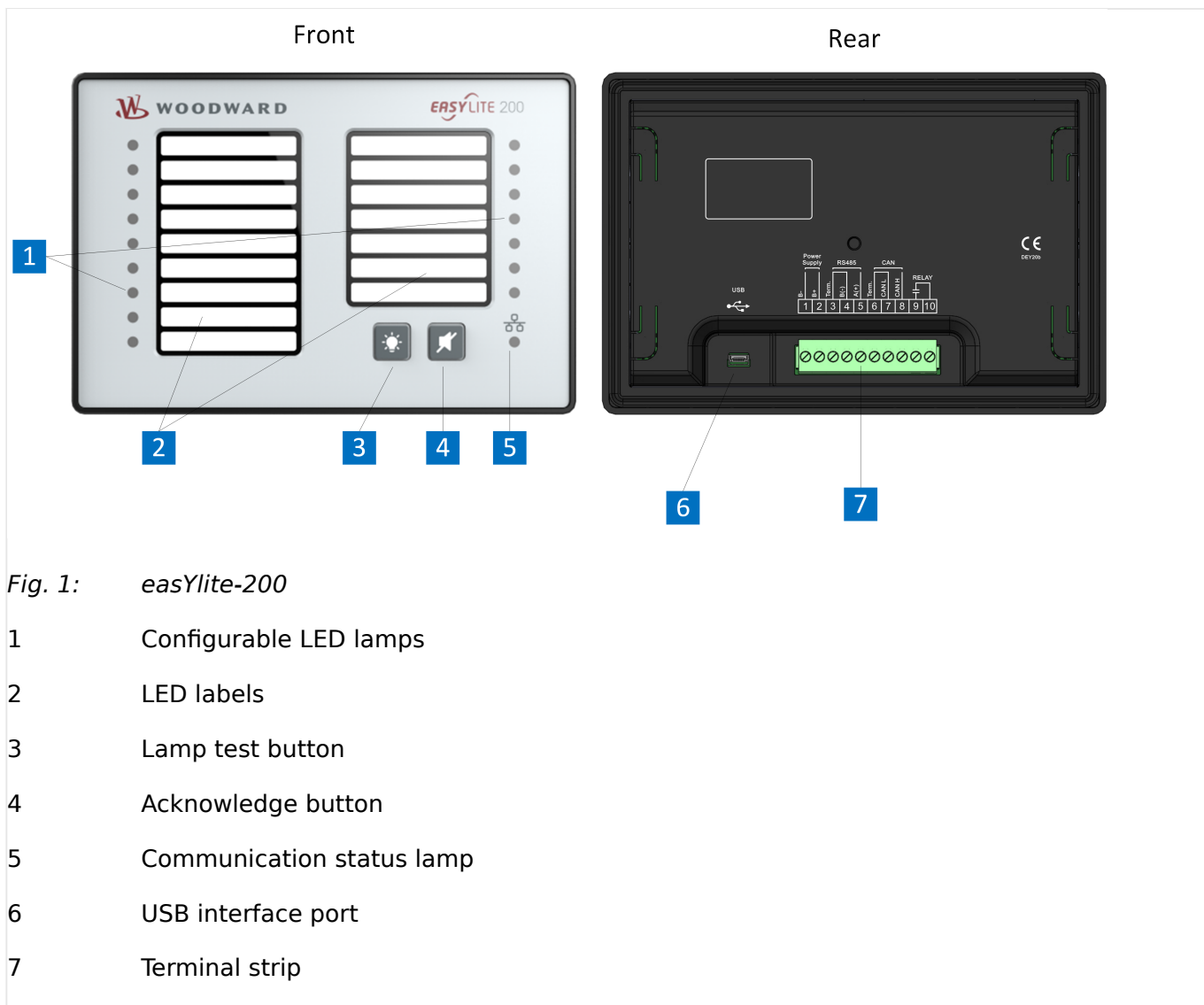

Fig. 1: easYlite-200

- 1 Configurable LED lamps
- 2 LED labels
- 3 Lamp test button
- 4 Acknowledge button
- 5 Communication status lamp
- 6 USB interface port
- 7 Terminal strip

General information

The easYlite-200 LED lamp expansion module is a LED display module with 16 programmable alarm, warning and status lamps, for which three colors (red, green, yellow) can be chosen. The data collected by easYgen series controllers are transmitted to the easYlite-200 for processing via CANBUS or RS485 port.

Each easYgen series controller can connect with up to two easYlite-200 modules.

Schematic easYlite-200

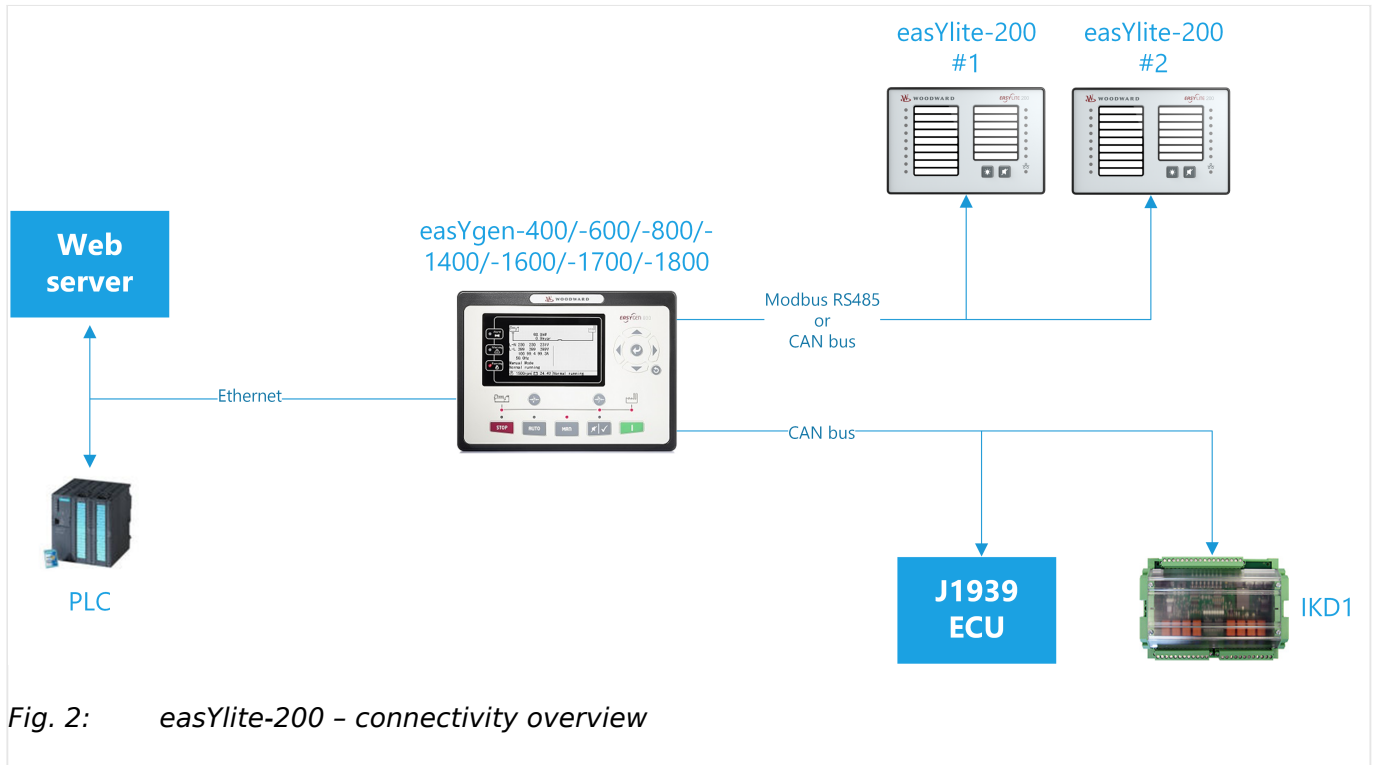

Fig. 2: easYlite-200 – connectivity overview

Scope of delivery

The following parts are included in the scope of delivery. Please check prior to the installation that all parts are present.

The following parts are included in the covering box. Please check prior to the installation that all parts are present:

- easYlite 200 LED lamp expansion module
All screwable terminal connectors are delivered with plug **and** jack
- Clamp fastener installation material (4x)
- »Installation Procedure Supplement« paper with links to the latest edition of Technical Documentation and software for download:
(<http://wwdmanuals.com/easYlite-200>)



Configuration software and Technical Manual are available at Woodward website:
(<http://wwdmanuals.com/easYlite-200>)

Table of Contents

1	General information	7
1.1	About This Manual	7
1.1.1	Revision history	7
1.1.2	Depiction Of Notes And Instructions	8
1.2	Copyright And Disclaimer	9
1.3	Service And Warranty	10
1.4	Safety	10
1.4.1	Intended Use	10
1.4.2	Personnel	11
1.4.3	General Safety Notes	12
1.4.4	Protective Equipment And Tools	14
2	System overview	16
2.1	Function overview	16
2.2	Display and Status Indicators	16
3	Installation	17
3.1	Installation	18
3.2	Terminal allocation	20
3.3	Wiring diagram	22
3.4	Power Supply	23
3.5	Relay outputs	24
3.6	Interfaces	25
4	Configuration	26
4.1	easYgen: LED Configuration and Labelling	26
4.2	ToolKit Configuration easYlite-200	29
4.2.1	Parameter Configuration	29
4.3	Interfaces	30
5	Operation	31
5.1	Front panel	31
5.2	Relay Output	32

Table of Contents

6	Applications	33
7	Technical Data	35
8	Appendix	37
9	Glossary And List Of Abbreviations	38
10	Index	40

1 General information

1.1 About This Manual

1.1.1 Revision history

Rev.	Date	Editor	Changes
D	2021-12	MK	Corrections/Repairs: <ul style="list-style-type: none">• updated revision history• added Approvals to chapter Technical Data• Updated download link.
C	2019-12	TM	Corrections/Repairs: <ul style="list-style-type: none">• corrected technical data of relays• corrected cutout dimensions• precised subtitle of label
B	2019-12	TM	New layout of document
A	2018-12-07	PW	Original release



Up to date documentation?

Please check Woodward web site for latest revision of this Technical Manual (search for "37903") and if there is an Errata Sheet with latest information (search for: "37904").

1.1.2 Depiction Of Notes And Instructions

Safety instructions

Safety instructions are marked with symbols in these instructions. The safety instructions are always introduced by signal words that express the extent of the danger.

DANGER!



This combination of symbol and signal word indicates an immediately-dangerous situation that could cause death or severe injuries if not avoided.

WARNING!



This combination of symbol and signal word indicates a possibly-dangerous situation that could cause death or severe injuries if it is not avoided.

CAUTION!



This combination of symbol and signal word indicates a possibly-dangerous situation that could cause slight injuries if it is not avoided.

NOTICE!



This combination of symbol and signal word indicates a possibly-dangerous situation that could cause property and environmental damage if it is not avoided.

Tips and recommendations



This symbol indicates useful tips and recommendations as well as information for efficient and trouble-free operation.

Additional markings

To emphasize instructions, results, lists, references, and other elements, the following markings are used in these instructions:

Marking	Explanation
	Step-by-step instructions
ð	Results of action steps
	References to sections of these instructions and to other relevant documents
■	Listing without fixed sequence

Marking	Explanation
»Buttons«	Operating elements (e.g. buttons, switches), display elements (e.g. signal lamps)
»Display«	Screen elements (e.g. buttons, programming of function keys)
[Screen xx / Screen xy / Screen xz] ...	Menu path. The following information and setting refer to a page in ToolKit-SC located as described here.
	Some parameters/settings/screens are available only in ToolKit-SC.



Dimensions in Figures

All dimensions shown with no units specified are in **mm**.

1.2 Copyright And Disclaimer

Disclaimer

All information and instructions in this manual have been provided under due consideration of applicable guidelines and regulations, the current and known state of the art, as well as our many years of in-house experience. Woodward assumes no liability for damages due to:

- Failure to comply with the instructions in this manual
- Improper use / misuse
- Willful operation by non-authorized persons
- Unauthorized conversions or non-approved technical modifications
- Use of non-approved spare parts

The originator is solely liable to the full extent for damages caused by such conduct. The agreed upon obligations in the delivery contract, the general terms and conditions, the manufacturer's delivery conditions, and the statutory regulations valid at the time the contract was concluded, apply.

Copyright

This manual is protected by copyright. No part of this manual may be reproduced in any form or incorporated into any information retrieval system without written permission of Woodward GmbH.

Delivery of this manual to third parties, duplication in any form - including excerpts - as well as exploitation and/or communication of the content, are not permitted without a written declaration of release by Woodward GmbH.

Actions to the contrary will entitle us to claim compensation for damages. We expressly reserve the right to raise any further accessory claims.

1.3 Service And Warranty

Opening the device will nullify any warranty!

CAUTION!



Any unauthorized modifications or use of this equipment outside its specified mechanical, electrical, or other operating limits may cause personal injury and/or property damage, including damage to the equipment.

Any such unauthorized modifications

- constitute "misuse" and/or "negligence" as per the product warranty
- thereby exclude warranty coverage for any resulting damage, and
- invalidate product certifications or listings.

Our Customer Service is available for technical information. Please see page 2 for contact details.

In addition, our employees are interested in any new information and experiences that arise from usage and could be valuable for improving our products.

Warranty terms



Please enquire about the terms of warranty from your nearest Woodward representative.

To find your closest Customer Service representative, go to: \Rightarrow <http://www.woodward.com/Directory.aspx>

1.4 Safety

1.4.1 Intended Use

The easYlite-200 is designed for use with a dedicated easYgen device. All functions described in this manual are only performable, if the correct easYgen are incorporated. Please refer to Woodward for the correct easYgen device.

NOTICE!***Damage due to improper use!***

Improper use of the genset control unit may cause damage to the control unit as well as connected components.

Improper use includes, but is not limited to:

- Storage, transport, and operation outside the specified conditions.

1.4.2 Personnel**WARNING!*****Hazards due to insufficiently qualified personnel!***

If unqualified personnel perform work on or with the control unit hazards may arise which can cause serious injury and substantial damage to property.

- Therefore, all work must only be carried out by appropriately qualified personnel.

This manual specifies the personnel qualifications required for the different areas of work, listed below:

- Well trained for electrical installations.
- Skilled and competent to be aware especially of the local safety regulations.
- Experienced in working on electronic measuring and control devices.
- Allowed to manage the controlled (engine/generator) system.

The workforce must only consist of persons who can be expected to carry out their work reliably. Persons with impaired reactions due to, for example, the consumption of drugs, alcohol, or medication are prohibited.

When selecting personnel, the age-related and occupation-related regulations governing the usage location must be observed.

1.4.3 General Safety Notes

Electrical hazards

DANGER!



Life-threatening hazard from electric shock!

There is an imminent life-threatening hazard from electric shocks from live parts. Damage to insulation or to specific components can pose a life-threatening hazard.

- Only a qualified electrician should perform work on the electrical equipment.
- Immediately switch off the power supply and have it repaired if there is damage to the insulation.
- Before beginning work at live parts of electrical systems and resources, cut the electricity and ensure it remains off for the duration of the work. Comply with the five safety rules in the process:
 - cut electricity;
 - safeguard against restart;
 - ensure electricity is not flowing;
 - earth and short-circuit; and
 - cover or shield neighboring live parts.
- Never bypass a fuse or render it inoperable. Always use the correct amperage when changing a fuse.
- Keep moisture away from live parts. Moisture can cause short circuits.

Prime mover safety

WARNING!



Hazards due to insufficient prime mover protection

The engine, turbine, or other type of prime mover should be equipped with an overspeed (over-temperature, or over-pressure, where applicable) shutdown device(s), that operates totally independently of the prime mover control device(s) to protect against runaway or damage to the engine, turbine, or other type of prime mover with possible personal injury or loss of life should the mechanical-hydraulic governor(s) or electric control(s), the actuator(s), fuel control(s), the driving mechanism(s), the linkage(s), or the controlled device(s) fail.

Modifications

WARNING!



Hazards due to unauthorized modifications

Any unauthorized modifications to or use of this equipment outside its specified mechanical, electrical, or other operating limits may cause personal injury and/or property damage, including damage to the equipment.

Any unauthorized modifications:

- constitute "misuse" and/or "negligence" within the meaning of the product warranty thereby excluding warranty coverage for any resulting damage
- invalidate product certifications or listings.

Use of batteries/alternators

NOTICE!



Damage to the control system due to improper handling

Disconnecting a battery from a control system that uses an alternator or battery-charging device whilst the charging device is still connected causes damage to the control system.

- Make sure the charging device is turned off before disconnecting the battery from the system.



Unit includes a lithium backup battery for Real Time Clock. Field replacement of the battery is not allowed.

In case of battery replacement please contact your Woodward service partner.

Electrostatic discharge



- Protective equipment: ESD wrist band



NOTICE!



Damage from electrostatic discharge

All electronic equipment sensitive to damage from electrostatic discharge, which can cause the control unit to malfunction or fail.

- To protect electronic components from static damage, take the precautions listed below.

1. ▷ Avoid build-up of static electricity on your body by not wearing clothing made of synthetic materials. Wear cotton or cotton-blend materials as much as possible because these do not store static electric charges as easily as synthetics.
2. ▷  Before working on terminals on the control unit, ground yourself by touching and holding a grounded metal object (pipes, cabinets, equipment, etc.) to discharge any static electricity.
Alternatively wear an ESD wrist band connected to ground.
3. ▷  Before any maintenance work on the control unit, ground yourself by touching and holding a grounded metal object (pipes, cabinets, equipment, etc.) to discharge any static electricity.
Alternatively wear an ESD wrist band connected to ground.
4. ▷ Keep plastic, vinyl, and Styrofoam materials (such as plastic or Styrofoam cups, cigarette packages, cellophane wrappers, vinyl books or folders, plastic bottles, etc.) away from the control unit, modules and work area.
5. ▷ Opening the control cover may void the unit warranty. Do not remove the printed circuit board (PCB) from the control cabinet unless instructed by this manual.



If instructed by this manual to remove the PCB from the control cabinet, follow these precautions:

- Ensure that the device is completely voltage-free (all connectors have to be disconnected).
- Do not touch any part of the PCB except the edges.
- Do not touch the electrical conductors, connectors, or components with conductive devices or with bare hands.
- When replacing a PCB, keep the new PCB in the plastic antistatic protective bag it comes in until you are ready to install it. Immediately after removing the old PCB from the control cabinet, place it in the antistatic protective bag.



For additional information on how to prevent damage to electronic components caused by improper handling, read and observe the precautions in:

- "Woodward manual 82715, Guide for Handling and Protection of Electronic Controls, Printed Circuit Boards, and Modules".

1.4.4 Protective Equipment And Tools

Protective gear

Personal protective equipment serves to protect risks to the safety and health of persons as well as to protect delicate components during work.

Certain tasks presented in this manual require the personnel to wear protective equipment. Specific required equipment is listed in each individual set of instructions.

The cumulative required personal protective equipment is detailed below:

ESD wrist band

The ESD (electrostatic discharge) wrist band keeps the user's body set to ground potential. This measure protects sensitive electronic components from damage due to electrostatic discharge.

Tools

Use of the proper tools ensures successful and safe execution of tasks presented in this manual.

Specific required tools are listed in each individual set of instructions.

The cumulative required tools are detailed below:

Torque screwdriver

A torque-screwdriver allow fastening of screws to a precisely specified torque.

Note the required torque range individually specified in the tasks listed in this manual.

2 System overview

2.1 Function overview

Description

The easYlite-200 expansion module is able to display warning, alarm or status messages of an easYgen Woodward genset controller remotely (for example in a remote control station). Two easYlites-200 can be connected to one 100- or 1000-series easYgen via CAN or RS-485 interfaces, over which genset control messages are transmitted for external signalling. One easYlite-200 module is able to display 16 different warning, alarm or status messages using LEDs, each freely configurable from the easYgen genset controller level.

In addition to this, the easYlite-200 has a relay output to connect an external signaling device (horn). The signaling device indicates then an alarm at the genset and/or failure of communication with its master easYgen device. When a warning, alarm or status message is issued at the genset control, the horn bit of the genset control is enabled. If the horn bit is assigned to an output relay of the easYgen, this relay will be energized, as well as the output relay of the easYlite-200.

2.2 Display and Status Indicators

General information

All status indication is hardware-based and realized by the easYlite-200 device's LEDs. In addition to status display, the front panel contains two control buttons, one for lamp test and one for acknowledge and reset of alarms.



For access to settings, configuration of device parameters and status/alarm indication, use of the software tool ToolKit-SC is necessary. See further details in [↳ “General information”](#).

3 Installation

General notes

NOTICE!



Avoid electrostatic discharge!

Before working with terminals please read and follow the instructions of chapter [↪](#) "Electrostatic discharge".

For CAN and RS485 shielded cabling, no more than 25 mm wiring exposed without shield coverage are allowed at terminal plug side.

NOTICE!



Malfunctions due to literal use of example values

All technical data and ratings indicated in this chapter are merely listed as examples. Literal use of these values does not take into account all actual specifications of the control unit as delivered.

- For definite values please refer to chapter [↪](#) "7 Technical Data".

Wire sizes



Field wiring shall be made with use of cables which have temperature rating not less than 90 °C.

AWG	mm ²	AWG	mm ²	AWG	mm ²	AWG	mm ²	AWG	mm ²	AWG	mm ²
30	0.05	21	0.38	14	2.5	4	25	3/0	95	600MCM	300
28	0.08	20	0.5	12	4	2	35	4/0	120	750MCM	400
26	0.14	18	0.75	10	6	1	50	300MCM	150	1000MCM	500
24	0.25	17	1.0	8	10	1/0	55	350MCM	185		
22	0.34	16	1.5	6	16	2/0	70	500MCM	240		

Table 1: Conversion chart - wire sizes

3.1 Installation

Housing dimensions

The easYlite-200 module is to be mounted using the included clips.

↳ Fig. 3 below shows the housing and cutout dimensions of the unit:

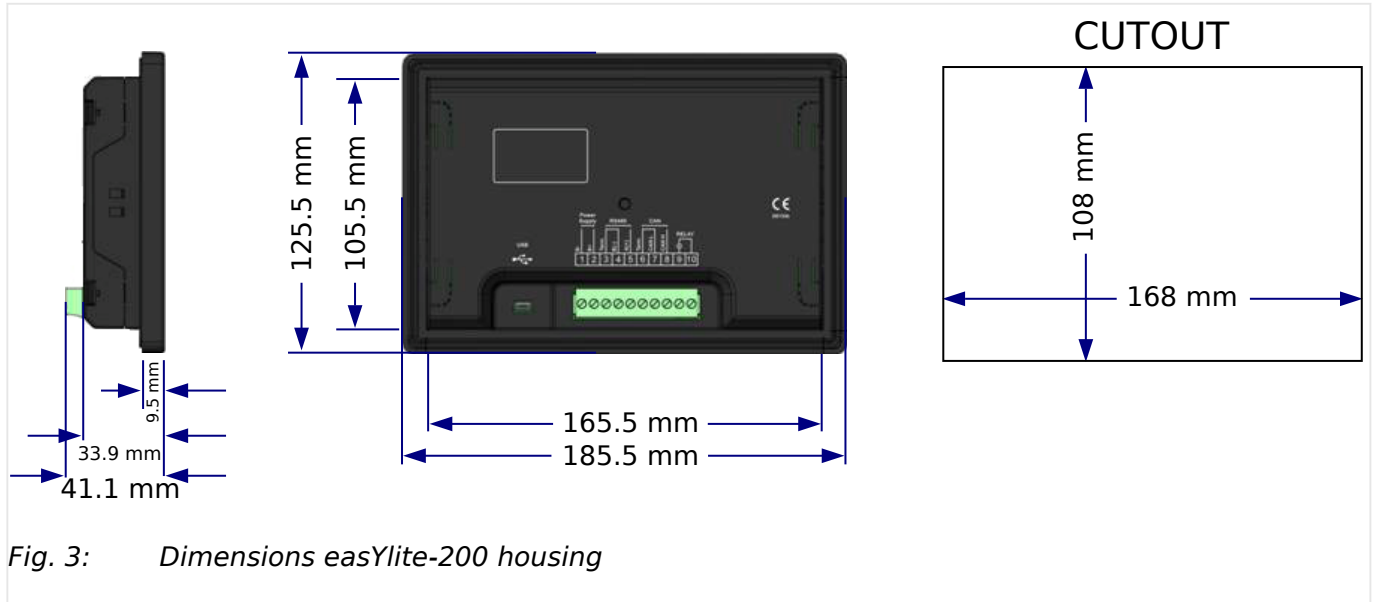

Fig. 3: Dimensions easYlite-200 housing

- ⚙
- > Proceed as follows to install the unit:
- 1. ▷ **Panel cutout**
 Cut out the panel according to the dimensions in ↳ Fig. 3.
- 2. ▷ **Remove terminals**
 Loosen the wire connection terminal screws on the back of the unit and remove the wire connection terminal strip if required.
- 3. ▷ **Loosen clamping screws**
 Loosen the four clamping screws until they are almost flush with the clamp inserts and tilt the clamp inserts down by 45° to remove them from the housing. Do not completely remove the screws from the clamp inserts.
- 4. ▷ **Insert unit into the cutout**
 Insert the unit into the panel cutout. Verify that the unit fits correctly in the cutout. If the panel cutout is not big enough, enlarge it accordingly. Ensure that the gasket is placed properly if used. Ensure that the paper strip is not pinched between gasket and panel to maintain isolation.
- 5. ▷ **Attach clamp inserts**
 Re-install the clamp inserts by tilting the insert to the angle of 45°. Insert the nose of the insert into the slot on the side of the housing. Raise the clamp insert so that it is parallel to the control panel.
- 6. ▷ **Tighten clamping screws**
 Tighten the clamping screws until the control unit is secured to the control panel. Over tightening of these screws may result in the clamp inserts or the housing breaking.
- 7. ▷ **Reattach terminals**

Reattach the wire connection terminal strip and secure with the side screws.



Tighten the clips (tightening torque 0.3 Nm [2.65 lb·in]) in order to achieve the IP65 degree of protection.



If the gasket is damaged, it needs to be replaced. Use only the original gasket kit (P/N 3050-1057) for replacement.

3.2 Terminal allocation

The rear panel of easYlite-200 with its terminals can be seen in  Fig. 4 below:

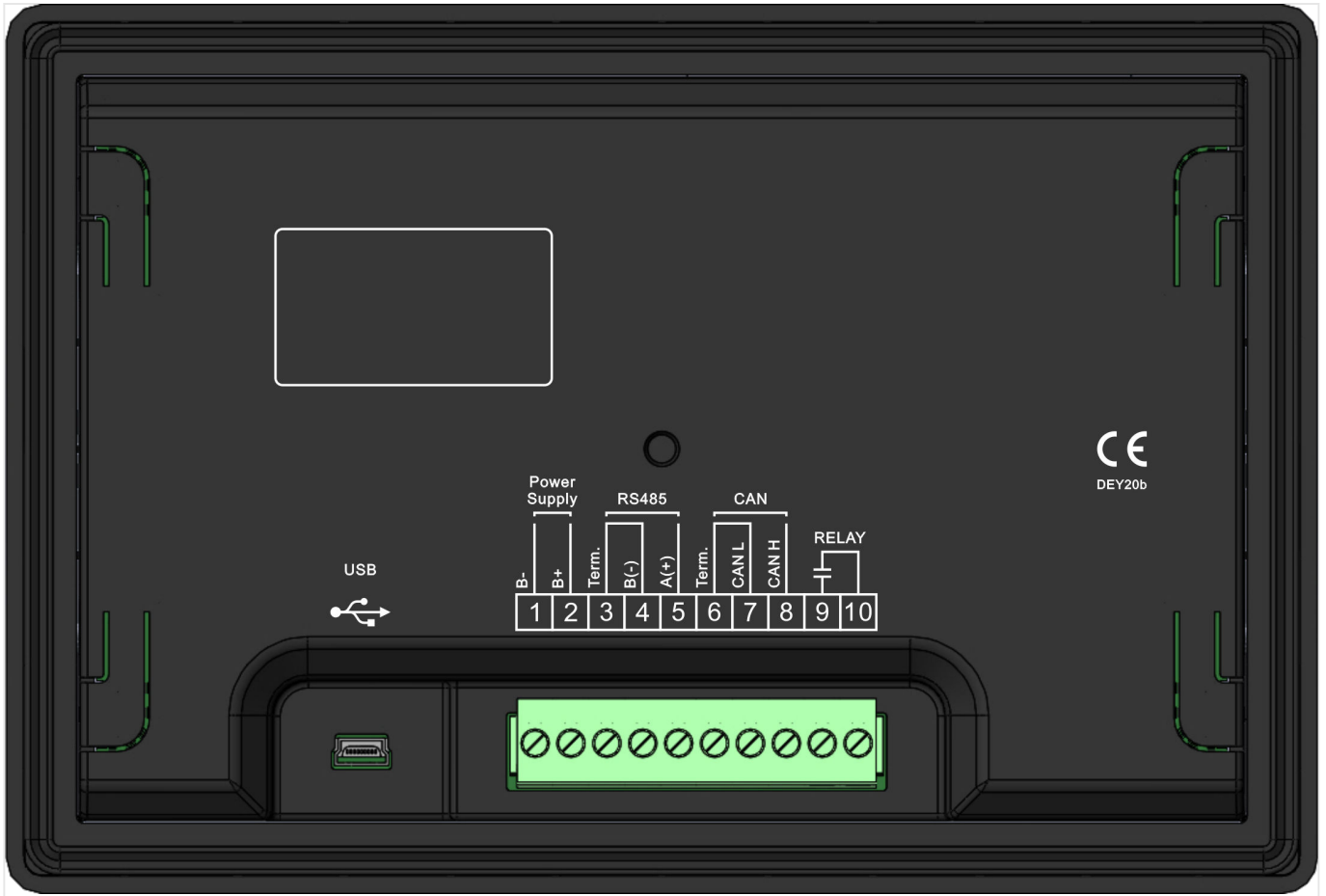

Fig. 4: easYlite-200, rear side view

No.	Function	Cable Size	Description
1	DC input B-	2.5 mm ²	DC power supply negative input.
2	DC input B+	2.5 mm ²	DC power supply positive input.
3	GND	0.5 mm ²	Modbus RS-485. Connect the RS-485 port to RS-485 port of easYgen series controllers. It is recommended to use a shield with the impedance of 120 Ω, with one end grounded. The terminal provides resistance of 120 Ω; if needed, short-circuit terminals 3, 4.
4	A (+)		
5	B (-)		
6	GND	0.5 mm ²	CAN bus. Connect the CAN bus port to CAN port of easYgen series controllers. It is recommended to use a shield with the impedance of 120 Ω, with one end grounded. The terminal provides
7	CAN (L)		
8	CAN (H)		

No.	Function	Cable Size	Description
			resistance of 120 Ω; if needed, short-circuit terminals 6, 7.
9	RELAY	2.5 mm ²	Relay output: 7 Aac 250 Vac, resistive, GP, potential-free contacts
10		2.5 mm ²	Common pin of relay

Table 2: easYlite-200 terminals

3.3 Wiring diagram

General Notes



Battery Voltage Input

This device can be used with batteries providing the operating voltage range from 8 to 35 V_{DC}.

The negative pole of the battery must be grounded. The wire between the power supply terminals and the battery must have a cross section above 2.5 mm².

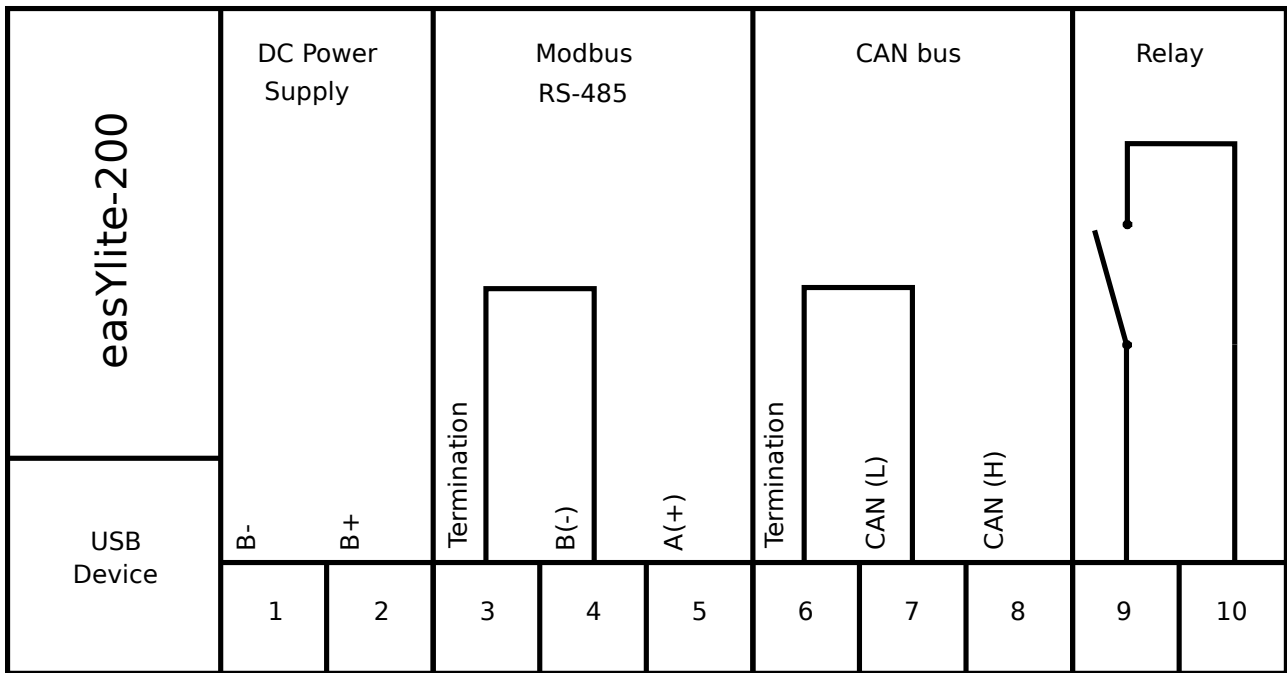

Fig. 5: Wiring diagram easYlite-200

3.4 Power Supply

General notes



Battery Voltage Input

This device can be used with batteries providing the operating voltage range from 8 to 35 V_{DC}.

The negative pole of the battery must be grounded. The wire between the power supply terminals and the battery must have a cross section above 2.5 mm².



Woodward strictly recommends to use power supply that fulfills the SELV restrictions (SELV = separated or safety extra-low voltage, see IEC)



Woodward GmbH recommends to use one of the following slow-acting protective devices in the supply line:

- LPS
- Class 2
- LVLE
- Listed DC fuse 4 A for 24 Vdc circuits

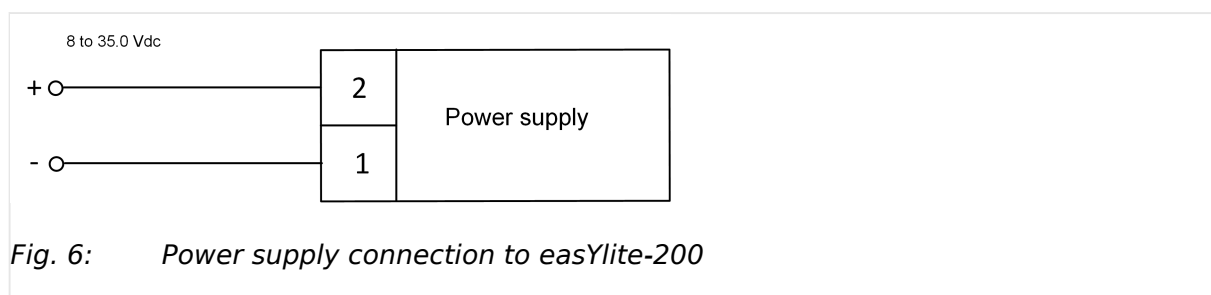

No.	Function	Cable Size	Description
1	DC input B-	2.5 mm ²	DC power supply negative pole.
2	DC input B+	2.5 mm ²	DC power supply positive pole.

Table 3: Power supply terminal assignment

3.5 Relay outputs

Schematic and terminals

The diagram below, [Fig. 7](#), shows the connection of the relay output of an easYlite-200 to an external signalling device:

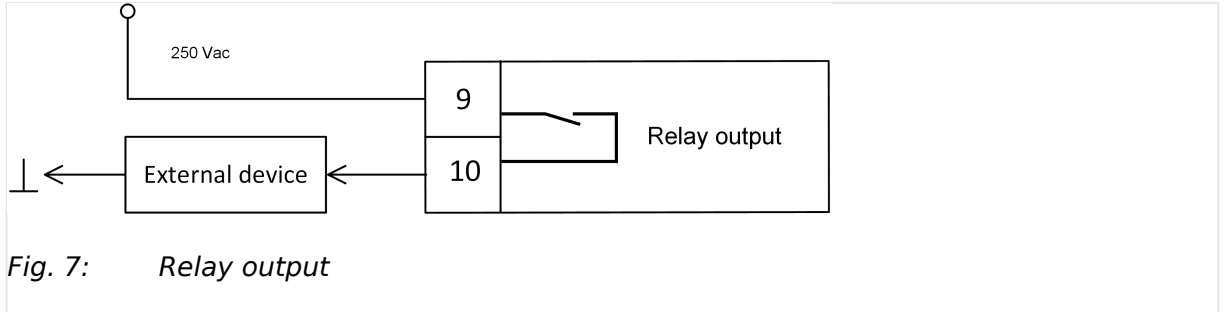

Fig. 7: Relay output

No.	Function	Cable Size	Description
9	RELAY	2.5 mm ²	Relay output: 7 Aac 250 Vac, resistive, GP, potential-free contacts
10		2.5 mm ²	Common pin of relay

3.6 Interfaces

General information

Connection examples and description of the terminals of communication interfaces can be seen below.

CAN bus

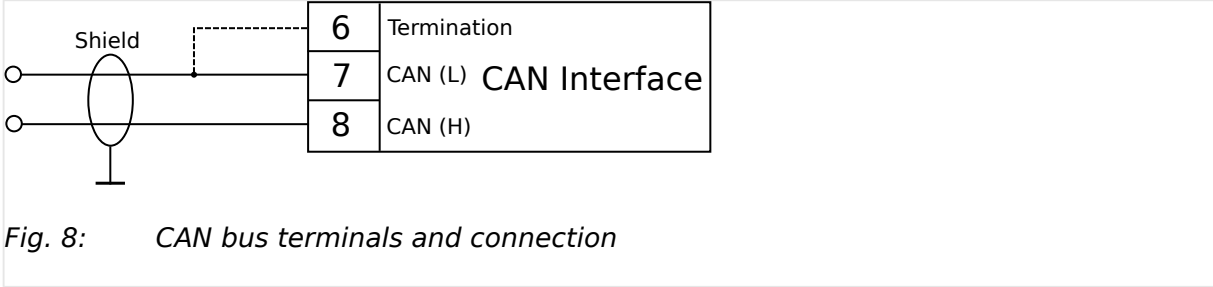

Fig. 8: CAN bus terminals and connection

No.	Function	Cable Size	Description
6	Termination	0.5mm ²	CAN bus terminals. Note: It is recommended that the cable shield be grounded at one end.
7	CAN (L)		
8	CAN (H)		

RS-485

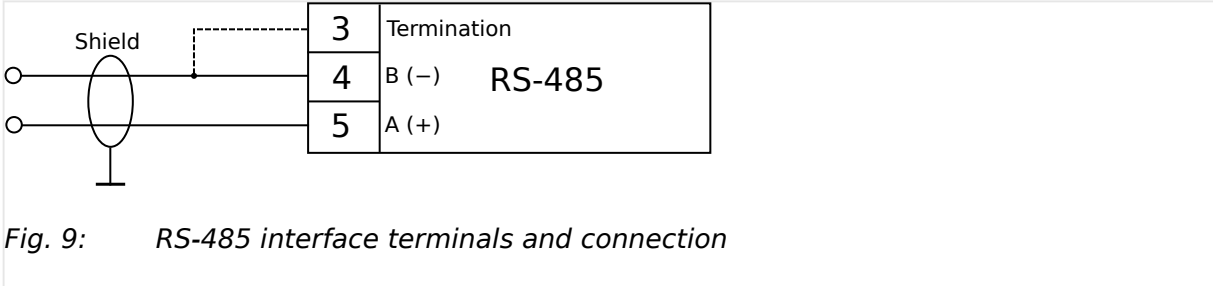

Fig. 9: RS-485 interface terminals and connection

No.	Function	Cable Size	Description
3	Termination	0.5mm ²	Modbus RS-485 terminals. Note: It is recommended that the cable shield be grounded at one end.
4	B (-)		
5	A (+)		

4 Configuration

General information

The easyLite-200 device is configured via the ToolKit-SC software. This may be done both in the respective 100-/1000-series easYgen's ToolKit-SC configuration screens (LED message assignment) and in the specific easYlite-200 ToolKit-SC configuration. The following subchapters provide a more detailed account of the configuration steps.

4.1 easYgen: LED Configuration and Labelling

The signal assignment/label content can be configured via 100-/1000-series easYgen's software ToolKit-SC. In order to do this, please go to [Parameter / Configure application / Configure Ext. LED].

The following screen appears as in  Fig. 10 below:

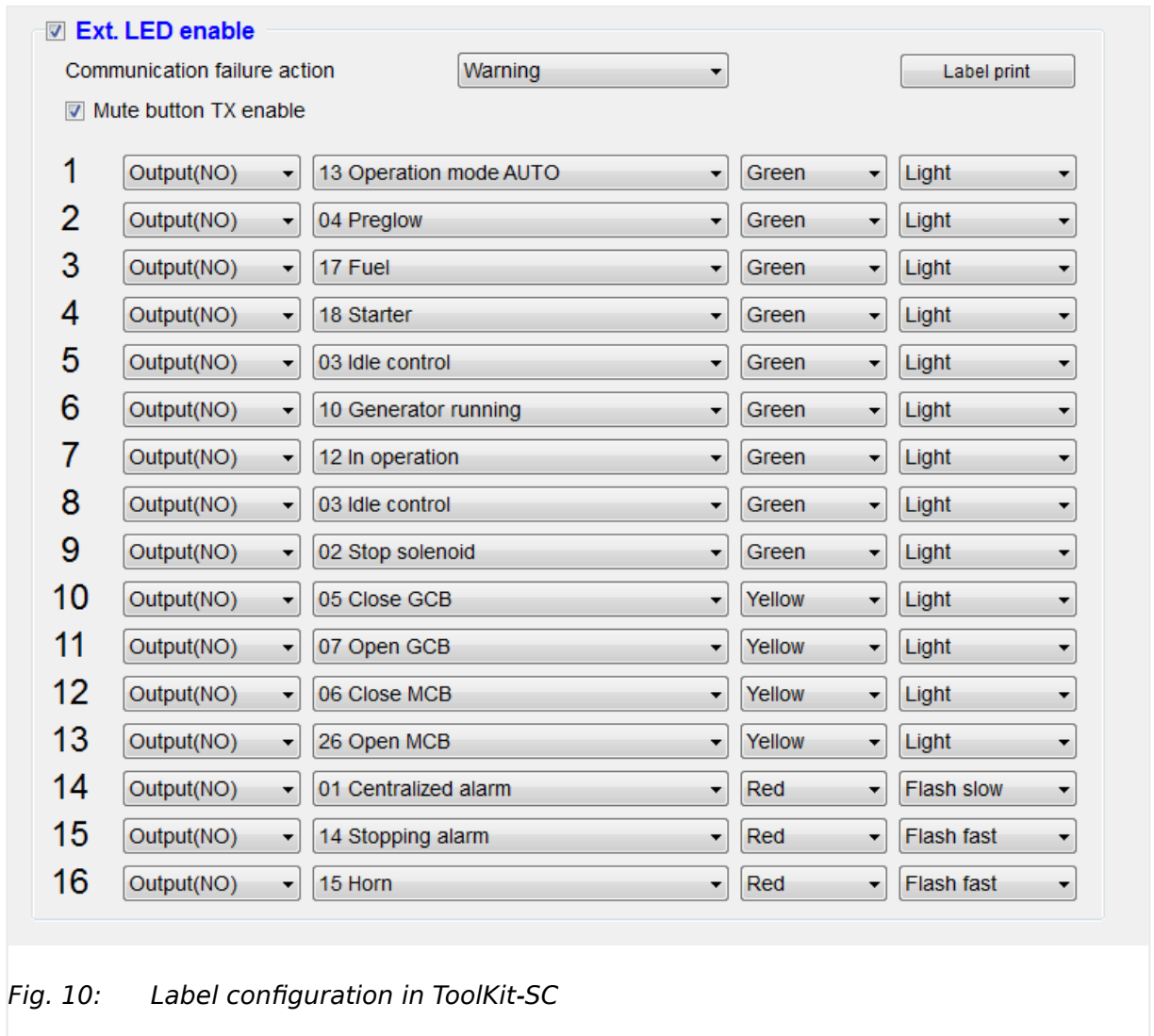

Fig. 10: Label configuration in ToolKit-SC

In the topmost drop-down list the user can select one of five actions, depending on the actual easYgen device, to be taken upon communication failure (Warning, Shutdown, Trip and Stop, Trip, Indication).

Below are the sixteen rows for the configurable signals, corresponding to easYlite-200's LEDs. In the first column, the output status can be selected (normally closed or normally open). In the second column, one of the parameters is selected to be associated with the

specific LED. The drop-down menu in the third column allows to specify the light color (red, green or yellow), while in the last one - the light output variation (continuous light, flashing fast, flashing slow).



For the actual list and descriptions of warnings/alarms/status messages assigned, see documentation of the respective 100-/1000-series easYgen device.

Where the “Mute button TX enable” box is checked in the ToolKit SC configuration screen, the easYlite-200 can silence the horn signal from the easYgen device (depending on the configuration). If this function is not active, the easYlite can only turn off its own flashing LEDs.

Once the configuration is complete, the user can print the LED labels by means of the “Label print” button. The following screen opens:

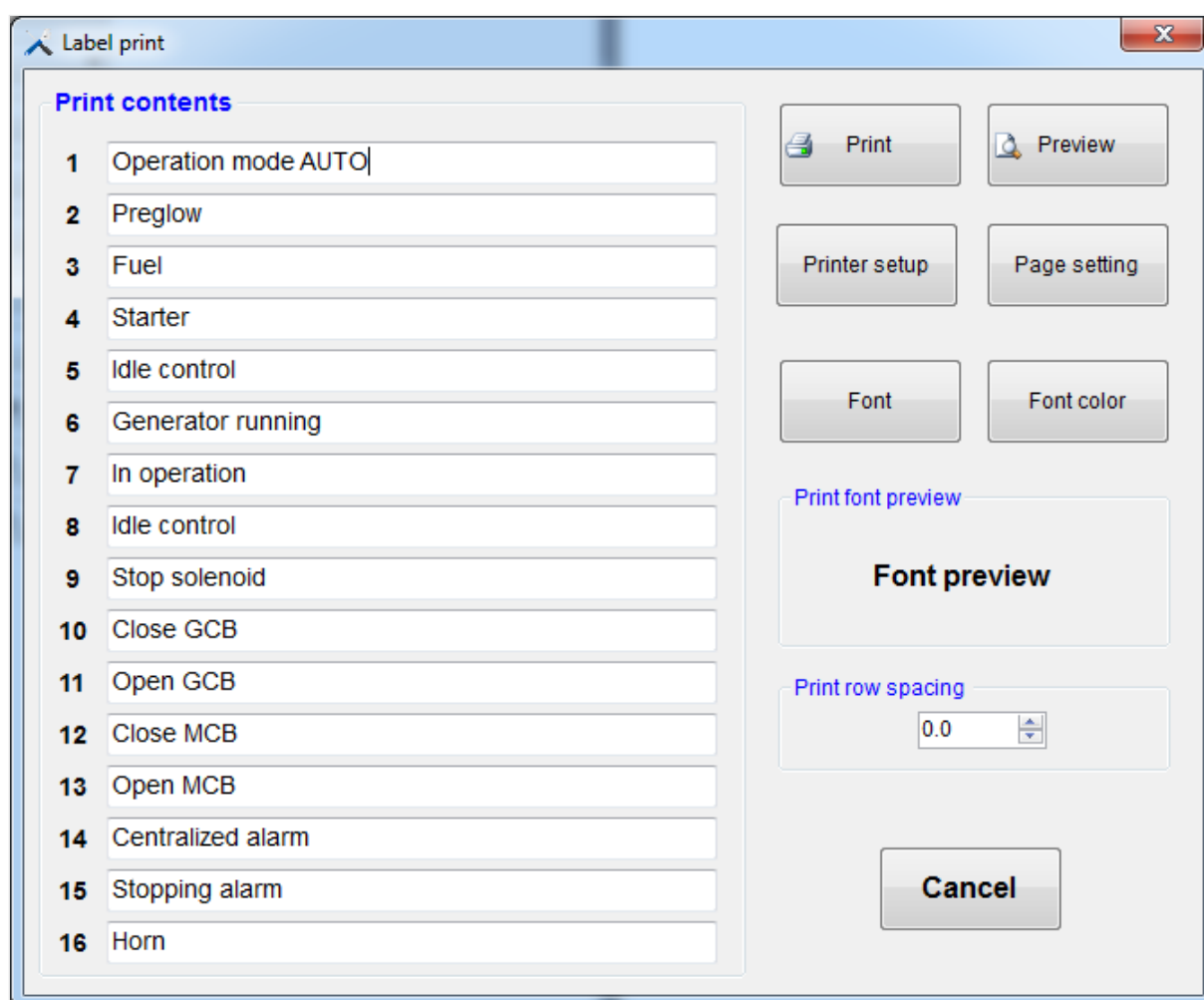



Fig. 11: Label print screen in ToolKit-SC

Once printed, the (two) paper strips with the signal designations can be inserted from top, as indicated by the arrows in  Fig. 12 below:

4 Configuration

4.1 easYgen: LED Configuration and Labelling

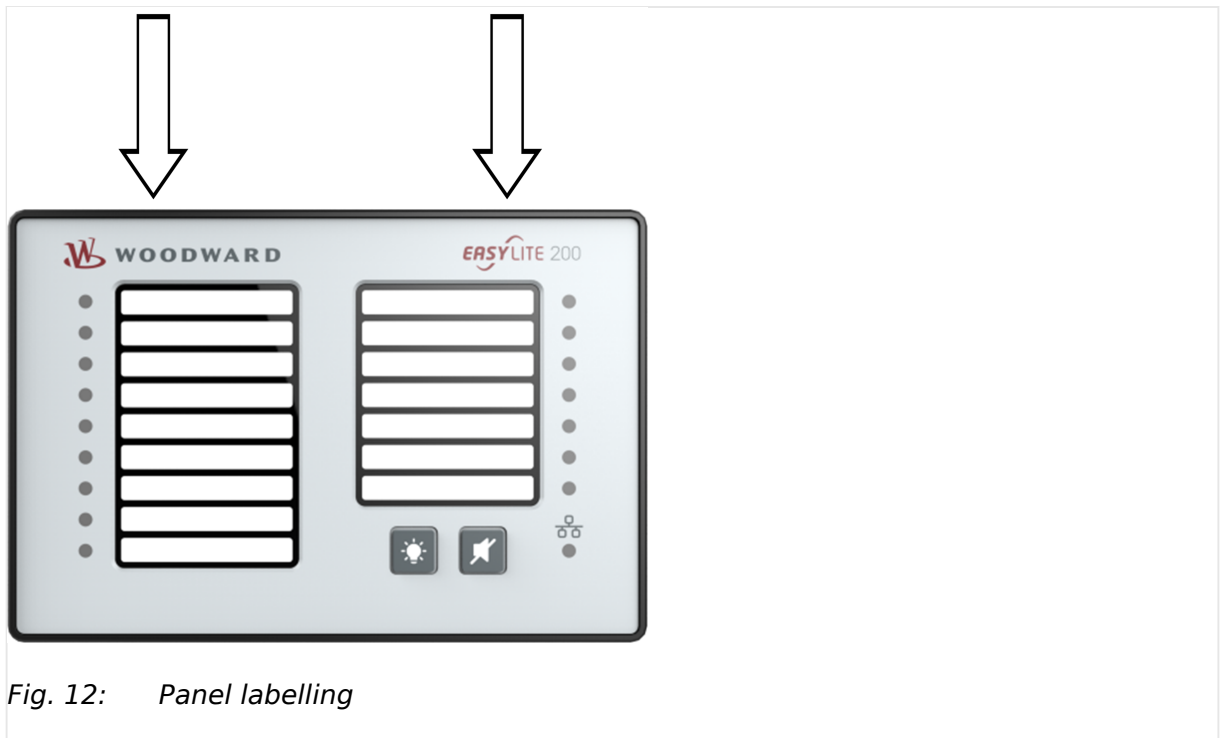

Fig. 12: Panel labelling



Please make sure that the size and position of the printed label correspond to the module. After cutting, the label can be inserted into the mask window from top.

4.2 ToolKit Configuration easYlite-200

4.2.1 Parameter Configuration

↳ Fig. 13 shows the ToolKit-SC configuration window, where easyLite-200's parameters can be set:

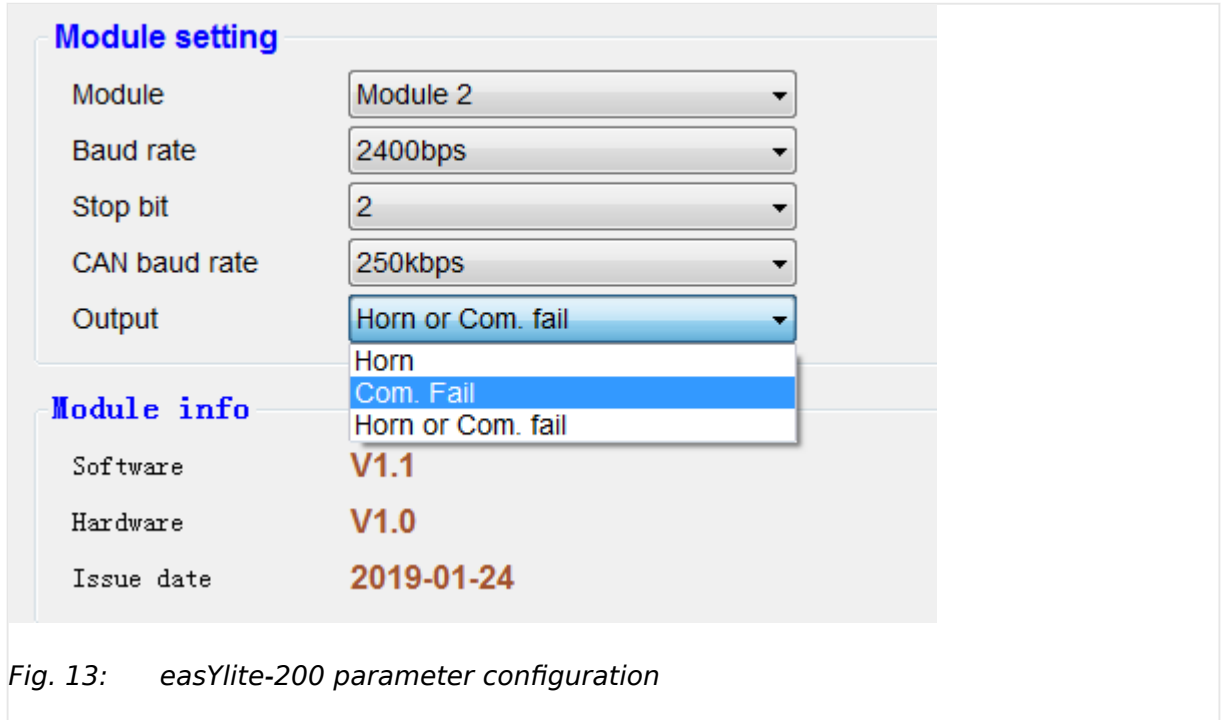

Fig. 13: easYlite-200 parameter configuration

In the first drop-down menu ("Module"), either of the two easYlite-200 devices is selected.

In "Baud rate", the rate of data transmission for RS-485 is set.

The third drop-down list allows to select the number of stop bits in the transmitted data (one or two) for RS-485, the fourth - the CAN bus baud rate.

Finally, in the fifth menu the bit is set for the relay output. If "Horn " is chosen, the relay will be energized upon incoming alarm set in the easYgen device. If "Com Fail" is selected, the output is closed when communication failure is detected. The third option enables to energize the relay when either of these takes place.



If the relay is configured to "Horn" or "Horn or Com fail", the relay will be energized upon any occurring genset alarm, regardless of whether the alarm is assigned to an easYlite-200 LED or not. It is recommended to also assign the configurable alarm message "Horn" to one of the easYlite-200 LEDs (see ↳ Fig. 11), in order to prevent an enabling of the horn without an alarm indication at the easYlite-200.

A detailed overview of the respective parameter settings and their explanation is contained in ↳ Table 4 below:

No.	Parameter	Setting range [Default]	Description
1	Module	0 to 1	0: Module 1 1: Module 2

No.	Parameter	Setting range [Default]	Description
		[0]	
2	Baud Rate	0 to 3 [3]	0: 2400 bps 1: 4800 bps 2: 9600 bps 3: 19200 bps
3	Stop bit	1 to 2 [2]	1 or 2 stop bits can be set.
4	CAN Baud Rate	0 to 1 [0]	0: 250 kbps 1: 125 bps
5	Relay Output	0 to 2 [0]	0: Audible alarm output ("Horn") 1: Communication fail output 2: Horn or comm. fail output

Table 4: Device configuration parameters

4.3 Interfaces



Please refer to respective 100-/1000-series easYgen's manual for detailed information about the configuration of interfaces used for communication with the easYlite-200.

5 Operation

5.1 Front panel

↳ Fig. 14 shows the front panel of the easYlite-200 device.

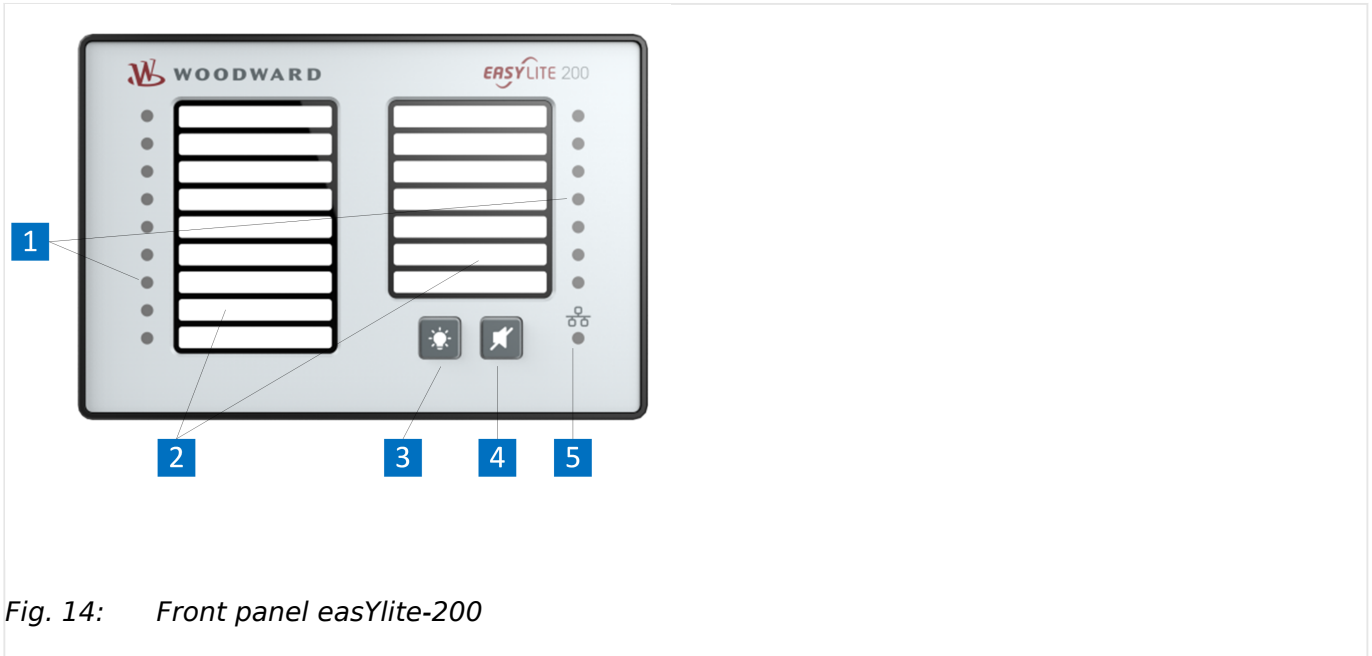

Fig. 14: Front panel easYlite-200

It consists of:

- 1 16 LED lamps
- 2 Labels for lamp-signal names
- 3 Lamp test button
- 4 Acknowledge button
- 5 Communication status lamp

LED lamps

The LED lamps 1 represent 16 signal outputs from an easYgen device, configurable as described in [↳ “2.2 Display and Status Indicators”](#). These may show various operational/parameter states of the easYgen device or the controlled apparatus (circuit breakers, engine), display warnings or alarms. The signalling for particular lamps is further differentiated by color (red, green, yellow) and lighting pattern (flashing, continuous).

LED Buttons

The control button 3 () is the lamp test button. All the lamps on the LED panel will be illuminated yellow upon long-pressing this button.

The control button 4 () is the acknowledge button. By depressing this button, the flashing lamp on the LED panel can be changed to continuously illuminated and the horn signal from the genset control can be silenced.

Operating the easYlite-200

When the easYlite-200 is powered up, the communication status lamp is illuminated green, while the remaining LEDs flash yellow for a short time (less than a second).

The communication bus status is indicated by the status lamp 5.

If a warning, an alarm or any predefined operational state is present, which is assigned to any of the sixteen LED lamps, the assigned lamp will illuminate in line with its configuration in ToolKit-SC.

If the horn is enabled by an alarm condition, it may be silenced with the acknowledge button 4, if this is configured in easYgen's ToolKit-SC.

A function test of all LEDs may be conducted by pressing the control button 3.

5.2 Relay Output

Description

The easYlite-200 device is equipped with an output relay to an external signaling device/horn.

It can be configured in three ways, with the respective output dependent upon the:

- status of the incoming horn signal (RPDO)
- status of the communication interface failure
- both.

It is reset as follows:

- Where set to "Communication failure", the relay is reset automatically if the the communication bus is ok.
- Where set to "Horn", it is reset by:
 - the acknowledge button, if the genset control configuration allows this 
 - horn acknowledgement on the genset control.

Silencing the horn

If the genset control has the horn activated, this can be silenced by pressing the

acknowledge button , if the genset control configuration allows this. This disables the horn of the genset control and the easYlite-200 output relay. A complete acknowledgement of the alarm, however, can only be performed on the genset control. Communication interface failures, which may result in energizing the output relay, cannot be silenced.

6 Applications

Up to two easYlite-200 devices can be connected to an 100-/1000-series easYgen over the available communication interfaces. Shown below are examples of easYlite-200 devices connected in parallel to easYgen's RS-485 (↪ Fig. 15) or CAN (↪ Fig. 16) terminals, respectively:

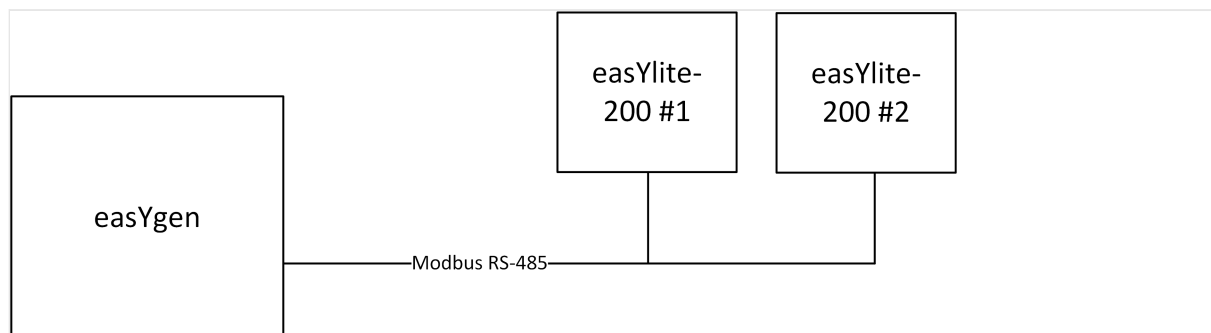

Fig. 15: RS-485 communication with the easYgen

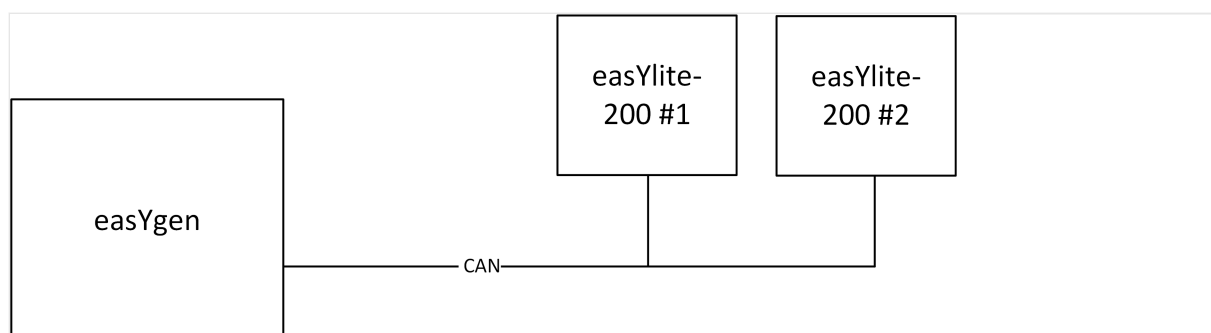

Fig. 16: CAN communication with the easYgen

An example application with multiple devices connected to the easYgen can be seen in ↪ Fig. 17 below:

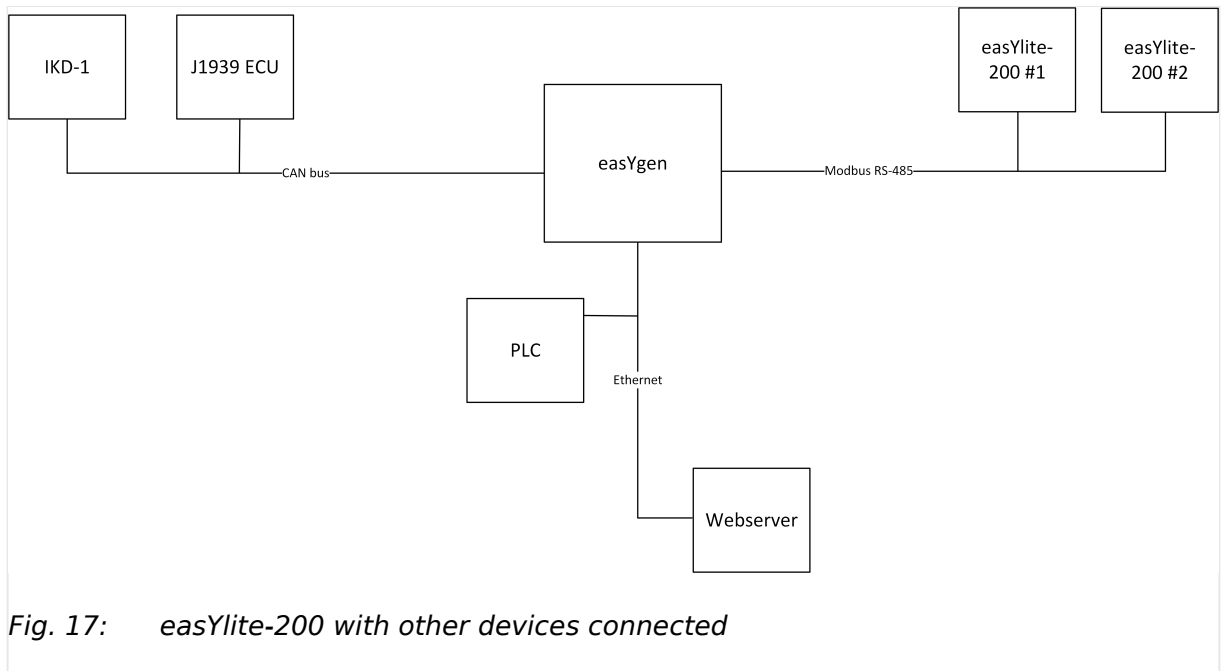

Fig. 17: easYlite-200 with other devices connected

7 Technical Data

Product label

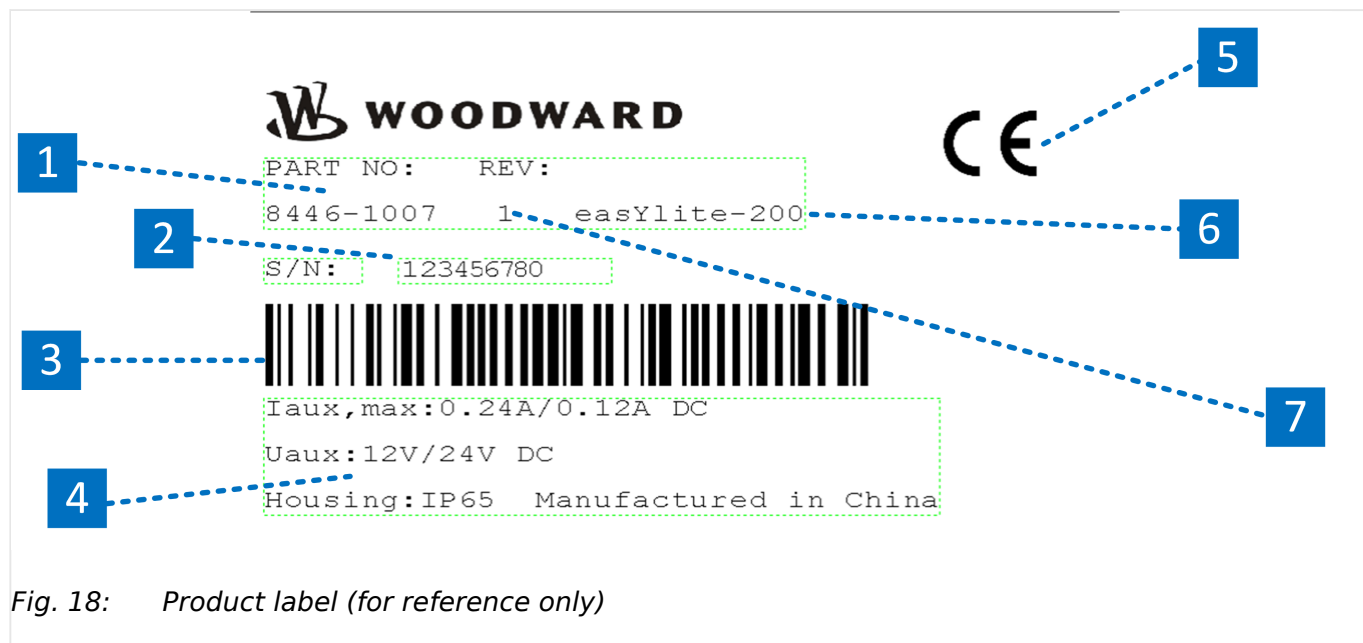
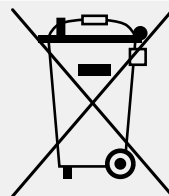

Fig. 18: Product label (for reference only)

Number	Name	Description
1	P/N	Item number
2	S/N	Serial number (numerical)
3	S/N	Serial number (barcode)
4	Details	Technical data
5	Approval	Approvals
6	Type Description	Description (product name)
7	REV	Item revision number

Waste Disposal

This device contains a battery, and therefore it is labeled with the following symbol according to the EU Directive 2006/66/EC:



Batteries can be harmful to the environment. Damaged or unusable batteries must be disposed of in a container that is specially reserved for this purpose.

In general, appropriate local guidelines and regulations must be followed when disposing of electrical devices and batteries.

Item	Content
Operating Voltage	$U_{DC} = 8.0 \text{ V} \dots 35.0 \text{ V}$ continuous power supply
Power Consumption	< 5 W
Output Relay	7 Aac 250 Vac, resistive, GP, potential-free contacts
Communication interfaces	1: A RS-485 (half duplex) isolated interface, MODBUS protocol 2: A CAN communication interface 3: A USB mini B type interface
Case Dimension	185.5 mm × 125.5 mm × 41.1 mm
Cutout	168 mm × 108 mm
Working Conditions	Temp. : (−25 ... 70)°C Relative Humidity : (20~93)%
Storage Conditions	Temp. : (−25 ... 70)°C
Protection Level	IP65: when water proof gasket ring inserted between panel and housing.
Weight	0.37 kg

Table 5: Technical parameters

Approvals

Item	Content
EMC test (CE)	Tested according to applicable EMC standards.
Listings	CE UL/cUL; FTPM/7; File E347132. EAC

8 Appendix

Troubleshooting

Problem	Possible Solution
Unit does not respond to power supply	Check the connection wiring.
CAN bus communication failure	Check if the interface conductors are not connected in the opposite way.
RS-485 communication failure	<p>Check the RS-485 negative/positive connection.</p> <p>Check whether the RS-485 converter works correctly or not.</p> <p>Check the Module address settings.</p> <p>If the problem still cannot be solved, please try to parallel a 120 Ω resistor between terminals A and B of the RS485 interface.</p>

Table 6: Possible problems with solutions

9 Glossary And List Of Abbreviations

AM	AnalogManager
BDEW	German community of 1,800 companies represented by the German Association of Energy and Water Industries (Bundesverband der Energie- und Wasserwirtschaft)
SPN	Suspect Parameter Number
FMI	Failure Mode Indicator
OC	Occurrence Count
CB	Circuit Breaker
CL	Code Level
CT	Current Transformer
DI	Discrete Input
DO	Discrete (Relay) Output
ECU	Engine Control Unit
EX-10	Woodward excitation module "easYgen exciter 10"
GAP	Graphical Application Programming (GAP™)
GC	Group Controller
GCB	Generator Circuit Breaker
GCP	Woodward device series (Genset Control) - not preferred for new design!
GGB	Generator Group Breaker
GOV	(speed) Governor; rpm regulator
HMI	Human Machine Interface e.g., a front panel with display and buttons for interaction
IOP	Islanded Operation in Parallel ("Islanded Parallel Operation")
LM	LogicsManager©
LSG	Woodward device: Load Share Gateway (communication converter)
MFR	Woodward device series (multifunctional relays) - not preferred for new design!
Operation	In (general) operation. State when the genset is running according to the selected mode, all parameters are in allowed values and ranges, and without OPEN requests or alarms. Somehow "waiting for next occurrence".
S/N	Serial Number
PT	Potential (Voltage) Transformer

P/N	Part Number
PLC	Programmable Logic Control
PID	Proportional Integral Derivative controller
PF	Power Factor
PV	Photovoltaic
N.O.	Normally Open (make) contact
N.C.	Normally Closed (break) contact
NC	Neutral Contactor
MPU	Magnetic Pickup Unit
MOP	Mains Operation in Parallel
MCB	Mains Circuit Breaker
LDSS	Load-Dependent Start/Stop operation
V	Voltage
I	Current
P	Real power
Q	Reactive power
S	Apparent power
Sequencer	A sequencer file is carrying specific settings e.g. to enable communication with and/or control of an expansion module. Such files can be prepared by Woodward.

Index

A

Alarms 16, 26
Application 33

B

Battery 22, 23
Buttons 31

C

Configuration 26
Contact person 10
Customer Service 10
Cutout 18

D

Dimensions 18

F

Front panel 31
Functions 16

I

Installation 18
Intended use 10
Interfaces 25

O

Operation 31

P

Personnel 11
Protective equipment 14

S

Service	10
Status messages	26
Symbols	
in the instructions	8

T

Technical specifications	35
Toolkit-SC	29
Troubleshooting	37

U

Use	10
-----------	----

W

Warnings	26
Warranty	10
Wiring	22



Woodward GmbH

Handwerkstraße 29 — 70565 Stuttgart — Germany

Phone +49 (0) 711 789 54-510

Fax +49 (0) 711 789 54-101

stgt-info@woodward.com